









Model Code: LUA130

### Included Accessories

 UMG	 ICM8	 6020
 DTA16		

### Optional Accessories

 DR007	 CBB245	 CBB368A

### Dimensions

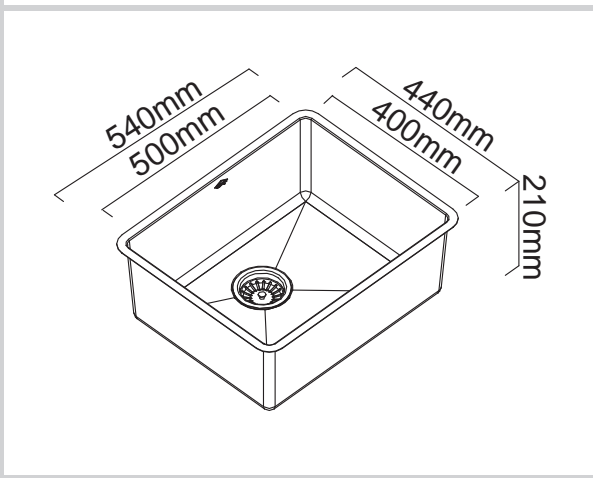

### Specifications

Description	Single bowl, Inset / Undermount Sink
Overall Sink Size	540mm x 440mm x 210mm deep
Bowl Dimensions	500mm x 400mm x 210mm deep
Drainer Length	N/A
Technic	Pressed
Material	Stainless steel SUS304

### Installation

Fixings	Inset and Undermount clips supplied
Template	N/A
Min Cabinet Size	630mm
Waste Holes	1 x 90mm round Compatible with waste disposal
Sealing Strip	N/A

### Plumbing

Waste Fittings	1 x (90mm x 2") basket waste included
Overflow	Available, conditions apply

### Packaging

Carton Type	EPS protection & Carton
Gross Weight	6.5Kg
Carton Size	620x 263mm x 518mm
Pack QTY	1

#### SURFACE FINISH



#### WASTE KIT

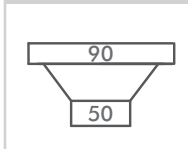

#### MATERIAL



#### INSTALLATION OPTIONS

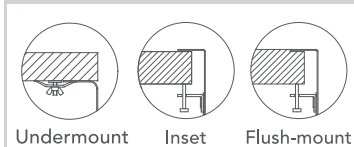

#### PROFILE

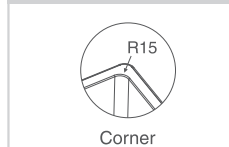

Abey are Australia's leaders in sinkware, designing and manufacturing to the world's highest quality specifications as well as sourcing and bringing you Europe's very best, leading edge designs – practical, affordable, inspirational, stylish, timeless or cutting edge. When you buy an Abey stainless steel sink you receive the highest quality and 25 year warranty. Abey and the manufacturer are continually seeking ways to improve the design specifications, aesthetic and production techniques of the products. As a result, alterations to the specifications and dimensions of the products and designs occur continually.