

LL156

LakeLand

Oliveri®

LEFT HAND BOWL SINK

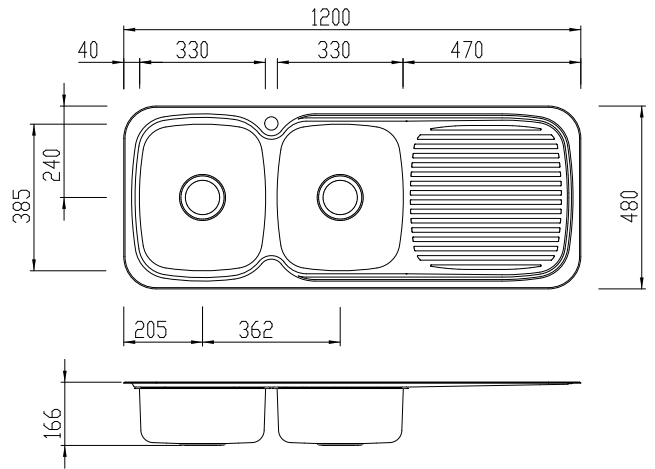

INCLUDED ACCESSORIES

AC14

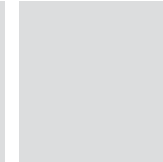
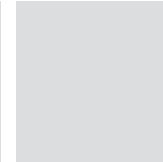
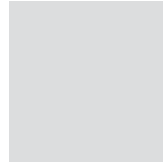
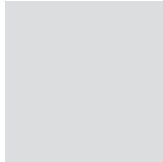

RECOMMENDED TAPWARE

NW7310



SS913



OPTIONAL ACCESSORIES

AC01

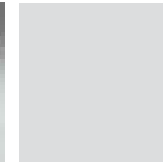
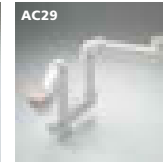
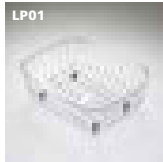

Australian Made Sink
 Oliveri

SPECIFICATIONS

Description

Double bowl inset sink with drainer

Sink Size

1200W x 480H

Main Bowl

330W x 385H x 155D / 17L

Main Bowl

330W x 385H x 155D / 17L

Construction

2 piece, bowls & drainer seam welded

Material

304 grade, 18/10 polished stainless steel (0.8mm thick)

Installation

Inset recommended.

Fixings

Adjustable clips and sealing foam supplied

Cut Out Template

1180 x 460 x 95mm radius

Min Cabinet Size

800mm

Tap holes

Available 0 or 1 tap hole (specify when ordering)

Waste fittings

2 x 90mm basket wastes included

Overflow

Available, conditions apply

Carton Size

1210 x 490 x 170mm

Weight

7.5kg

Warranty

Lifetime manufacturer's warranty (refer to oliverisinks.com)

For more information call **1300 13 7465** or visit **www.oliverisinks.com**

