







Model Code: FRA700

Included Accessories

| | | |
|---|---|---|
|  |  |  |
| ICM | UMG | 6020 |

Optional Accessories

| | | |
|--|--|--|
|  | | |
| DTA-18-316 | | |

Dimensions

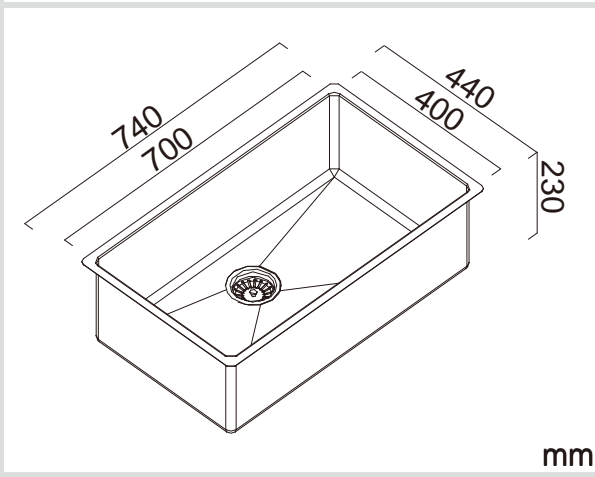

Specifications

| | |
|--------------------------|---|
| Description | Single bowl, Inset or flush-mount Undermount Sink |
| Overall Sink Size | 740mm x 440mm x 230mm deep |
| Bowl Dimensions | 700mm x 400mm x 230mm deep |
| Drainer Length | N/A |
| Thickness | 1.2mm |
| Material | Stainless steel SUS316 |

Installation

| | |
|-------------------------|--|
| Fixings | Inset & Undermount clips supplied |
| Template | N/A |
| Min Cabinet Size | 790mm |
| Waste Holes | 1 x 90mm round Compatible with waste disposal |
| Sealing Strip | N/A |

Plumbing

| | |
|-----------------------|---------------------------------------|
| Waste Fittings | 1 x (90mm x 2") basket waste included |
| Overflow | N/A |

Packaging

| | |
|---------------------|-------------------------|
| Carton Type | EPS protection & Carton |
| Gross Weight | 7.8Kg |
| Carton Size | 823mm x 286mm x 513mm |
| Pack QTY | 1 |

SURFACE FINISH



WASTE KIT

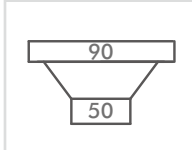

MATERIAL



INSTALLATION OPTIONS

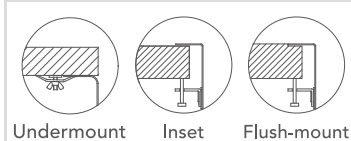

PROFILE

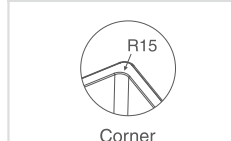

Abey are Australia's leaders in sinkware, designing and manufacturing to the world's highest quality specifications as well as sourcing and bringing you Europe's very best, leading edge designs – practical, affordable, inspirational, stylish, timeless or cutting edge. When you buy an Abey stainless steel sink you receive the highest quality and 25 year warranty. Abey and the manufacturer are continually seeking ways to improve the design specifications, aesthetic and production techniques of the products. As a result, alterations to the specifications and dimensions of the products and designs occur continually.