

DWA6315W2 SMEG WHITE FREESTANDING DISHWASHER

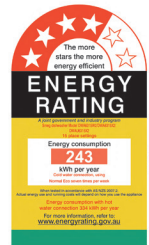

ORBITAL WASH SYSTEM

Smeg's orbital wash system has a major spray arm and satellite spray arm which spins ten times for every single revolution of the major spray arm to ensure water is thoroughly distributed in-between every piece in the wash for exceptional results.

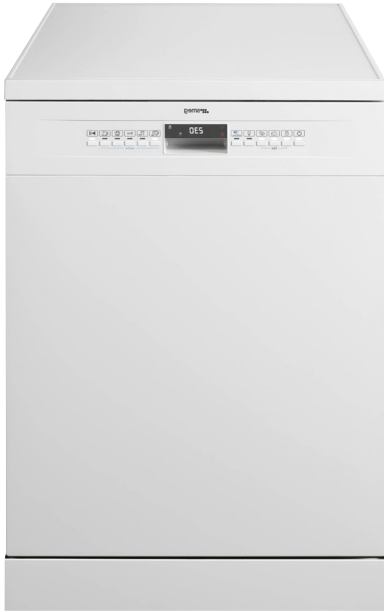
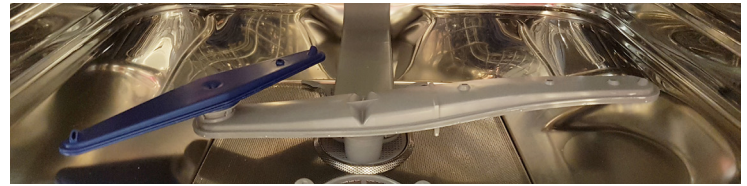

SmartDry (Enersave)

Smeg has developed a unique automatic door-opening system, which you can select as an option to open the door slightly at the end of the wash program. The open door allows steam from the wash to escape, reducing condensation and the residual heat of the machine allows the wash to dry naturally and thoroughly, without the consumption of additional energy.



Child safety lock

A must for families with young children, Smeg has developed an electronic system for locking the dishwasher controls. Children can press the buttons without interrupting the wash program. It's also convenient for parents, deactivating with a simple two button combination.



Active AcquaStop

Active AcquaStop electronically determines when and how much water to let into the dishwasher, automatically controlling the water feed at the tap. It's a major advantage of a Smeg dishwasher, because there is no water in the hose and therefore no building water pressure, where problems most often occur. Active AcquaStop is one of five distinctive water safety and flood prevention features in all Smeg dishwashers.



Aquatest

Smeg's Aquatest is a turbidity sensor which measures solids suspended in water and adjusts the water flow in the dishwasher according to the amount of soiling. This saves both water and energy, whilst ensuring a thorough clean for every wash.

EAN 8017709278854

Size	598mmW x 600mmD x 848mmH
Capacity	15 place settings
Finish	White
Display	LCD
Programs	5 + 5 Quick Programs
End of cycle indicator	On display, with acoustic signal
Baskets	3 Levels
Wash system	Orbital Wash System
Water softener	Yes – with electronic setting
Temperatures	38°, 45°, 50°, 65°, 70°C
Features	Quicktime wash setting for each program ½ Load FlexiZone FlexiTabs Fully adjustable upper and middle baskets Self Balancing Hinges
Water connection	Hot or cold Water Connection (60°C Max)
Timer	Up to 24 hours, with automatic soak
Filtration	Stainless steel 5 stage filter
Drying	Natural condenser drying with SmartDry (Enersave)
Safety	Child safety system (door lock) Active AcquaStop
Noise	47dBA
Water usage	9.9 Litres
Power	1800W 220-240V 50/60Hz 10A

DISHWASHERS

Functions



Quicktime



Flexizone

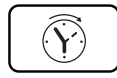

Delay

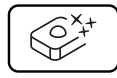

Flexitab



Energysave

Programs



soak



Normal ECO



Eco

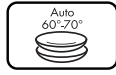

Auto 60-70



Ultraclean



Rapid 27



Normal Quick



Eco Quick



Daily Quick



Strong and Fast

Quick Programs

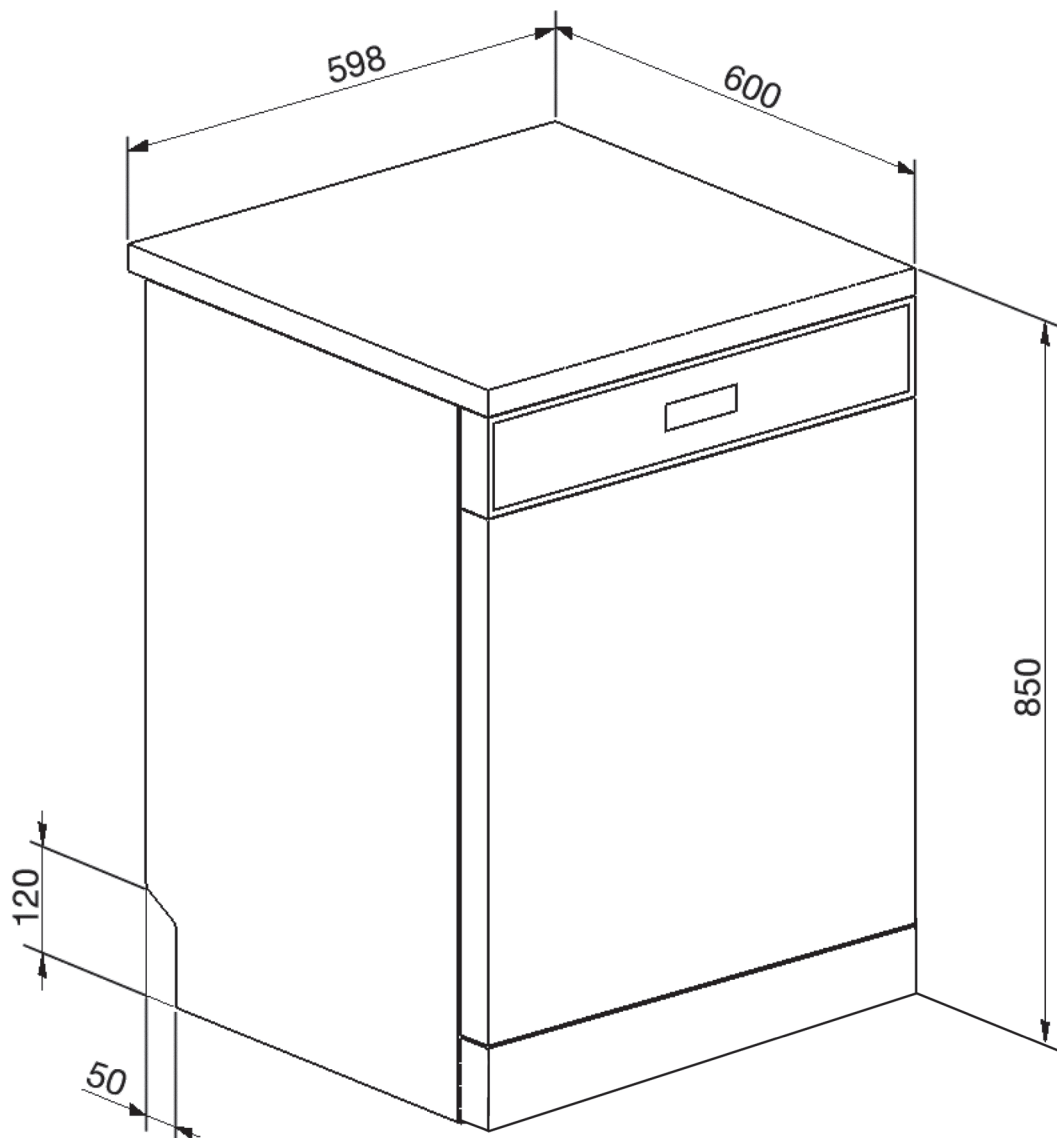

PLEASE NOTE: drawings are not to scale. They are to assist only.
WARNING: technical specifications and product sizes can be varied by the manufacturer without notice.
Cutouts for appliances should only be by physical product measurements. The above information is indicative only.